

A Highly Flexible Research Grade Mass Spectrometer

# AXIMA Performance



# AXIMA Performance™ - the Next Generation in MALDI CID MS/MS

A high performance MALDI-TOF-TOF mass spectrometer utilizing state-of-the-art high-energy MS/MS, delivering unparalleled flexibility, in a robust and reliable research grade system.



- Highest energy collisions – CID with a laboratory frame collisional energy of 20 keV
- Outstanding sensitivity – uncompromised design, to ensure no MS/MS signal is discarded
- Low sample consumption – allowing many more MS/MS experiments to be performed on the same sample spot
- Variable repetition rate laser
- Optimal precursor ion selection resolution using revolutionary ion gating technology
- Manual or fully automated operation allowing the seamless analysis of as few or as many samples as required
- Fully enabled for protein identification – Intellimarque™ software suite for automated data-dependent peptide mass fingerprinting and MS/MS of peptides with optional incorporated Mascot® database searching
- LC-MALDI software allowing confident identification of off-line separated complex mixtures via automated MS/MS

## Essential features providing confident results

This next generation design MALDI system delivers all of the features expected of an AXIMA series mass spectrometer:

- High resolution MS data in reflectron mode for more accurate and confident analysis
- Uncompromised linear mass range and sensitivity
- Near-axis laser irradiation for enhanced ion transmission and sensitivity in all modes of operation
- Advanced calibration algorithms with easy-to-use software providing more accurate data
- Intuitive software incorporating data-dependent workflows for achieving the maximum result with the minimum user input, making it ideal for novice and expert users alike
- Flexibility – this is a true workhorse. Polymers, oligonucleotides, SNPs, metabolites, carbohydrates and small molecules amongst others may all be analyzed and processed.

## Advanced MS/MS performance

The monoPULSE™ high performance, revolutionary ion gate provides outstanding MS/MS precursor ion selection resolution. When complex mixtures are analyzed, the high resolution ion gate allows optimal isolation of ions with similar nominal mass, affording successful separation of MS/MS fragmentation patterns, producing more and higher confidence identifications. Resulting MS/MS spectra are easier to interpret and significant database search hits are more readily achieved. The high-energy collisions, together with the curved field reflectron (CFR) produce well-balanced, information-rich MS/MS data.

- The unique combination of the advanced curved field reflectron design and the high-energy collision cell means that all fragment ions formed are detected, regardless of where they are formed in the instrument. Both LID and CID ions are accumulated into a seamless spectrum providing the best possible MS/MS sensitivity.
- The Low Mass Zoom™ (LMZ) feature allows rapid enhancement of the region of the spectrum encompassing the immonium ions and isotopically labelled quantitative diagnostic ions.
- Gridless ion path, unique to leading MS/MS systems, designed to avoid unwanted ion scattering and ensure the highest possible ion transmission.
- High sensitivity allowing multiple MS/MS acquisitions on the same sample spot through low sample consumption.

# AXIMA Performance™ - High Performance in a Robust and Flexible Design

## A practical and ergonomic package

The compact floor-standing geometry is designed to maximize laboratory space and allow easy installation and servicing. The system is delivered ready to install, requiring little assembly on site.

Attention has been paid to the important factors of cost of ownership and lifetime operational costs, minimizing the risk to the investor. The system has undergone the most rigorous and extensive quality assurance program, to ensure high reliability and robustness, in the best Shimadzu tradition.

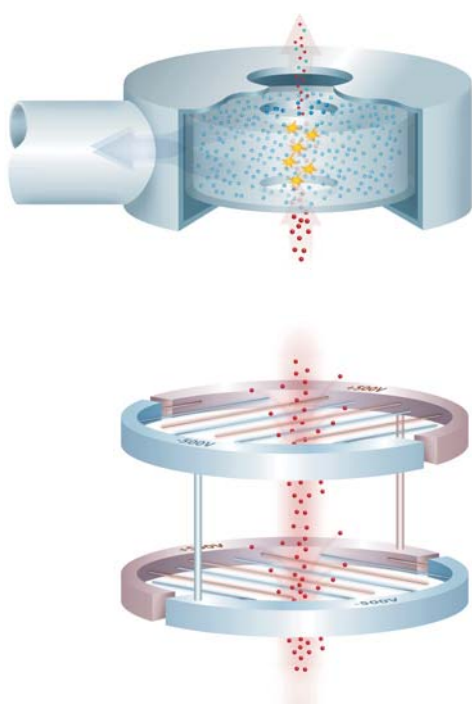

As with all AXIMA series systems, industry standard microtitre plate format MALDI targets are used for convenience and simple experimental planning and tracking. This allows seamless integration with a variety of robotic sample handling systems.

Modular target adaptors permit the use of many different sample target formats including FlexiMass™ and other microscope slide formats.

All AXIMA systems can be fully supported throughout their lifetime using sophisticated web-based service diagnostics and realtime remote monitoring. Highly trained specialist local service support engineers are available to install and maintain AXIMA mass spectrometers. A wide range of service contracts is available, catering for all budgets and requirements, including IQ/OQ environments and high throughput QA laboratories.

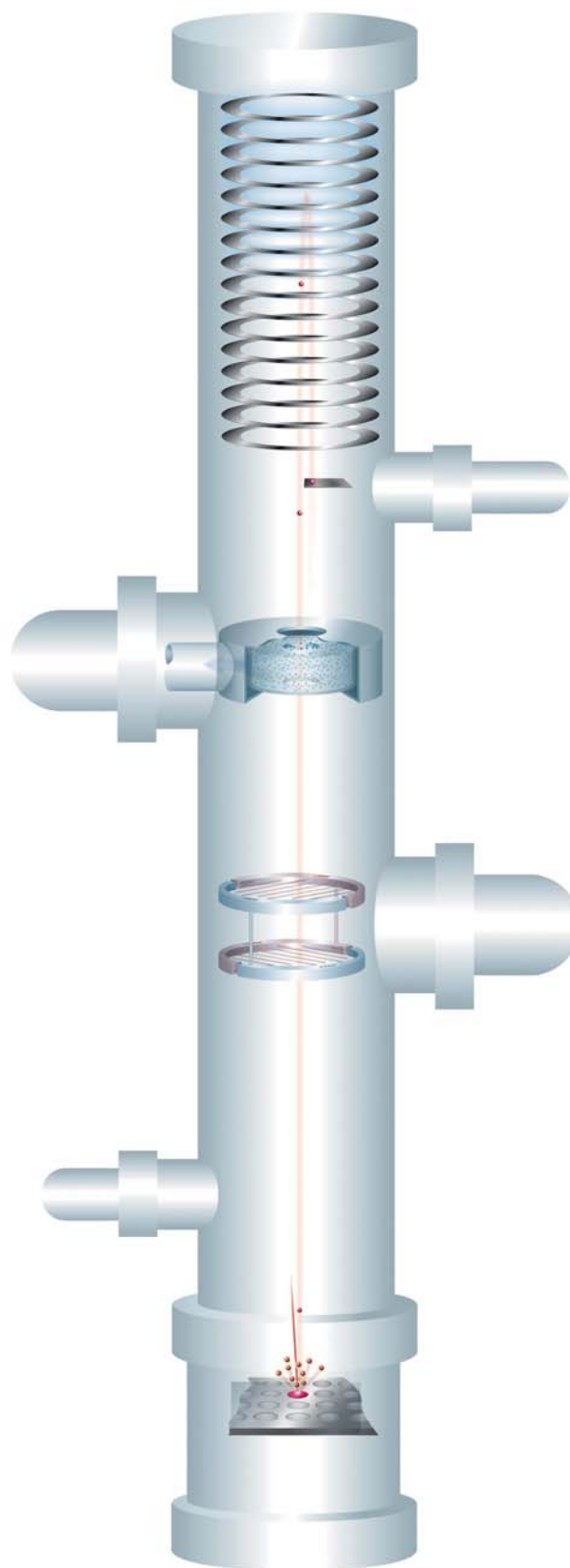

# AXIMA Performance™ - Excellence without Compromise

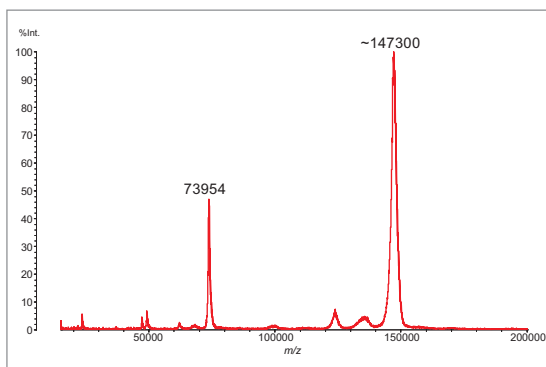

Linear MS spectrum of Immunoglobulin G

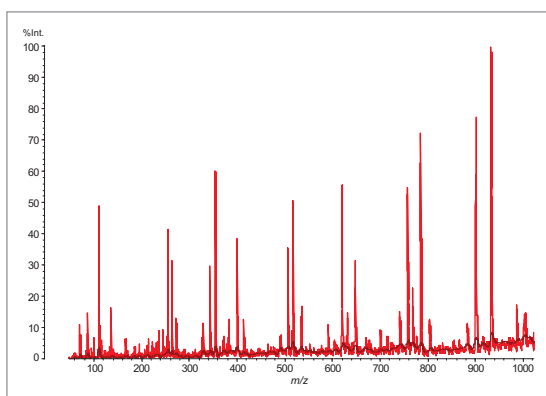

Typical high-energy CID MS/MS spectrum

## High performance MS data

The AXIMA Performance demonstrates high resolution and mass accuracy across a wide mass range, from pharmaceutical compounds, through peptides to high mass proteins, to enable a variety of applications in the research environment. A highly optimized linear mode generates reproducible and sensitive results for very high mass compounds and complexes, extending the array of sample classes that may be analyzed. A typical example of an intact high mass protein, Immunoglobulin G, is shown (left).

## Powerful precursor ion selection

The revolutionary monoPULSE ion gate allows the selection of MS/MS precursors with industry-leading resolution. Ions from complex mixtures or closely associated neighbouring isotopic envelopes may be isolated and subsequently fragmented. The gate resolution of greater than 400 (FWHM) readily permits the analysis of peptides with similar nominal mass, even with overlapping isotopic distributions.

## Efficient MS/MS from high-energy CID

Once selected for MS/MS fragmentation, precursor ions are subjected to true high-energy collisions with the chosen collision gas, e.g. helium. The resulting fragment ions are analyzed in the second TOF region incorporating the curved field reflectron and detected with the ultrafast MCP detector.

The high sensitivity means that good quality, usable MS/MS spectra can often be obtained for low sample amounts.

The novel additional Low Mass Zoom (LMZ) scan allows focus of the analysis to be directed around the low mass region of the MS/MS spectrum. This feature can be employed to increase confidence in MS/MS based quantitation experiments and to aid in *de novo* sequencing of unknowns by enhancing the immonium ion region of the spectrum.

# AXIMA Performance™ - Application-centric Solutions

## Protein identification

Designed with the flexibility to adapt to users' workflows: from single sample manual acquisition to fully automated data-dependent peptide mass fingerprinting (PMF) and MS/MS for protein identification.

- Peptide mass fingerprints are acquired and subjected to an optional integrated Mascot® database search.
- User-defined acceptance limits for PMF-based protein identification.
- Data-dependent MS/MS: using the results of the PMF search, MS/MS may be performed on ions that were matched to the top ranked protein hit (confirmation MS/MS), in addition to those that did not (investigation MS/MS). Batch searching of these MS/MS spectra is then performed automatically to provide additional and higher confidence protein identifications.
- Data may be reprocessed and resubmitted for database searching at a later time to provide additional information.

## LC-MALDI

- The AXIMA Performance provides total support for LC-MALDI based experiments.
- The software suite allows the fully automated acquisition of LC separated samples deposited onto MALDI targets and the subsequent identification of proteins via MS/MS of the peptides detected.
- The workflow automatically provides a provisional intensity map of all sample spots across the target to assess the distribution of peptides and identify the position of the apex of the chromatographic peaks. These are utilized to generate a candidate list and MS/MS data is acquired for all discrete peptide ions.
- Exclusion lists are used to remove known contaminants or high abundance peptides.
- All data is then subjected to an integrated Mascot® search.
- Low sample consumption allows multiple spectra to be acquired from the same spot increasing the amount of MS/MS data obtained.

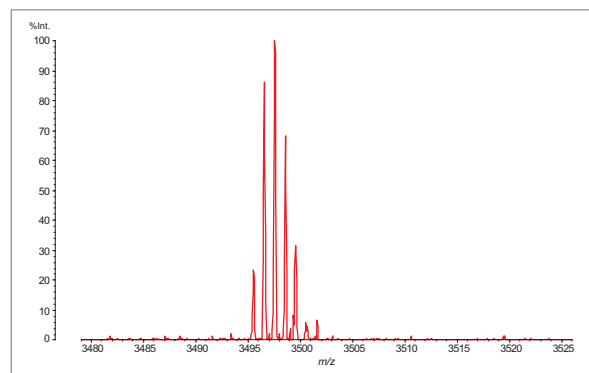

MS spectrum of Insulin B chain demonstrating resolution >20,000 (FWHM)

## Biomarker discovery

This exciting area encompassing clinical sample screening and profiling is comprehensively addressed using automated acquisition methods and refined data processing.

Data can be easily exported to third party software packages to allow comparative experiments using a number of standard data formats including ASCII, mzXML and mzData.

## Versatility

- The system's flexibility and uncompromised linear mode performance lends itself to alternative applications such as quality control.
- Launchpad™ software offers a module, Oligo Analysis™, for performing fully automated QC analysis of large numbers of oligonucleotides, peptides or small molecules, complete with a report indicating the presence or absence of a target compound, an estimate of the purity and occurrence of known contaminants, adducts or truncated/extended analogues.
- Polymer applications are fully catered for using our unique polymer analysis software, Polymer Analysis™, suitable for use with both polymers and copolymers.

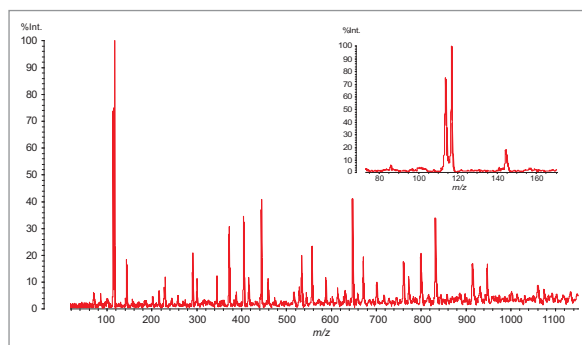

Typical MS/MS spectrum obtained by automated acquisition

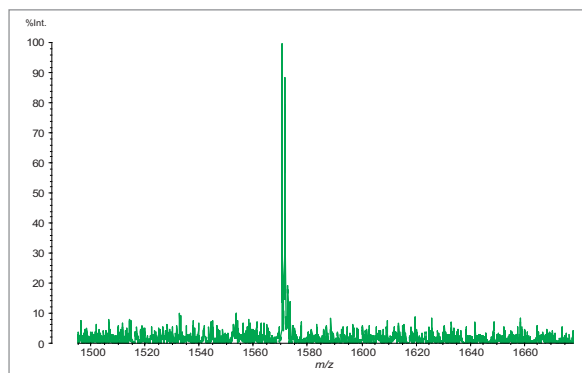

Peptide MS spectrum demonstrating attomole level sensitivity



**Kratos Analytical Ltd.**

Wharfside, Trafford Wharf Road, Manchester M17 1GP, UK

Phone: +44 161 888 4400 Fax: +44 161 888 4402

URL <http://www.shimadzu.com/an/>



Shimadzu Corporation

[www.shimadzu.com/an/](http://www.shimadzu.com/an/)

**For Research Use Only. Not for use in diagnostic procedures.**

This publication may contain references to products that are not available in your country. Please contact us to check the availability of these products in your country.

Company names, products/service names and logos used in this publication are trademarks and trade names of Shimadzu Corporation, its subsidiaries or its affiliates, whether or not they are used with trademark symbol "TM" or "®".

Third-party trademarks and trade names may be used in this publication to refer to either the entities or their products/services, whether or not they are used with trademark symbol "TM" or "®".

Shimadzu disclaims any proprietary interest in trademarks and trade names other than its own.

The contents of this publication are provided to you "as is" without warranty of any kind, and are subject to change without notice.

Shimadzu does not assume any responsibility or liability for any damage, whether direct or indirect, relating to the use of this publication.